



Capabilities Briefing

Sept 2017

Introduction

- ▶ Avion Partners, Inc. is an aviation and aerospace professional services corporation founded in 1999 with expertise in:
 - Program Management
 - Systems and Project Engineering
 - System Selection and Integration
 - Software Development
 - Flight Test and Airworthiness/Certification
 - Supplier Management

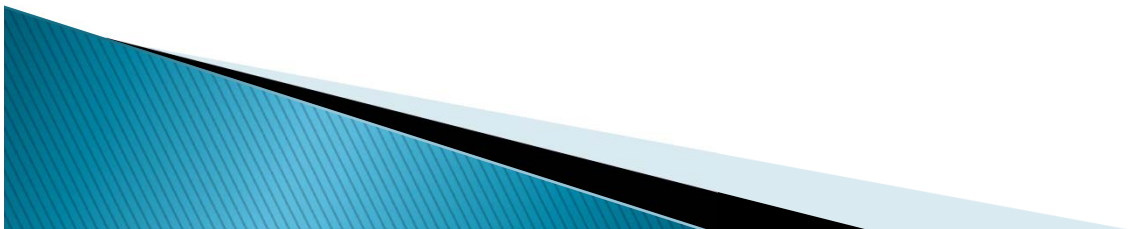

About Our People

- ▶ Each of Avion's two principals has over 30 years of Avionics and Aerospace experience.
- ▶ Staff is predominately degreed engineers, including advanced degrees and/or PMP certifications
- ▶ Avion's staff averages greater than 20 years aerospace experience and over 6 years tenure with the company
- ▶ Avion's resources are consist of two Partners, full-time employees and subcontractors
- ▶ We are well integrated into the local, regional and national consulting community providing access to a broad talent base that allows Avion to build a team based on project needs



Program Management **AVION**

- ▶ Avion's program management team develops and executes:
 - Project management processes and procedures for complex system development programs based on the Project Management Book of Knowledge (PMBOK) and industry best practices
 - Program schedule/plans for requirements development and compliance
 - Compliance with CFR's, Aviation and industry based requirements
 - Risk mitigation and tracking metrics for program and management review

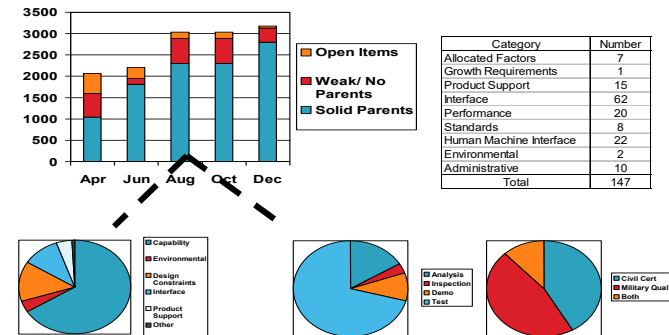
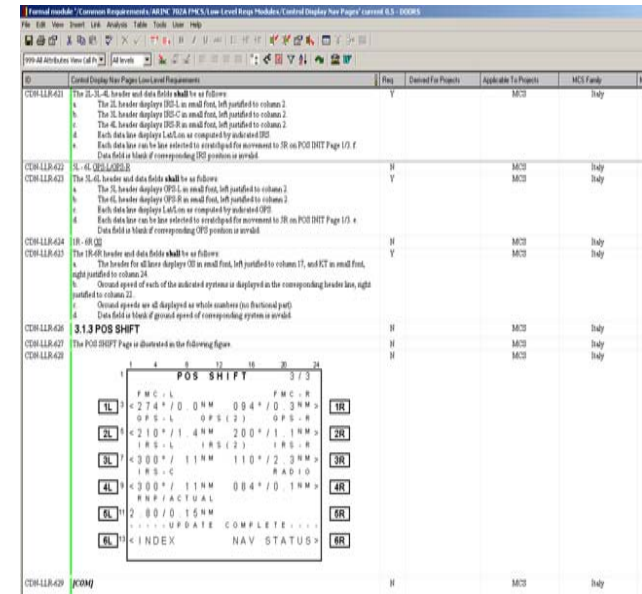

Systems and Project Engineering

AVION

- ▶ Airplane Systems Engineering
 - Generating System Requirements and Specifications (AR&O, SR&O, DR&O)
 - Integrating with Other Aircraft Systems
 - Defining Test Requirements and Environment
 - Implementing and Maintaining Requirements Management Tools (DOORS)
- ▶ Project Engineering
 - Responsible for all technical aspects of a program
 - Single point of contact for technical issues with customer and PM
- ▶ Utilities, Information and Data Systems
 - Connectivity Systems
 - Cabin Management
 - In-Flight Entertainment
 - Flight Deck and Avionics
 - Radar/Navigation
 - Flight Controls
 - LED Cabin Lighting
 - Power Distribution
 - Air-to-Air Refueling
 - Auxiliary Fuel Systems
 - Propulsion
 - VIP Cabin

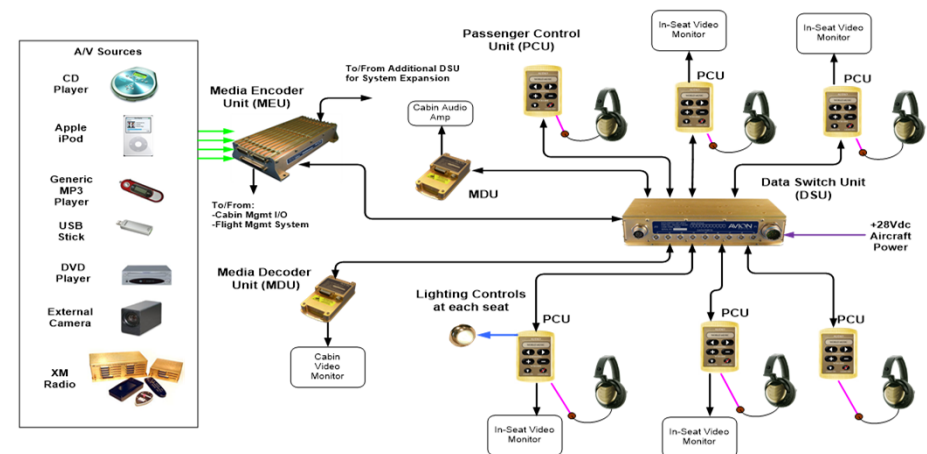

Systems Selection/Integration

- ▶ Avion stands ready to assist in system selection and integration
 - Market research
 - Objective rankings
 - Integrating new and legacy systems

- ▶ One prime example is today's IFC rush which needs informed decision makers to work through the various technologies and suppliers
 - Knowledge of the existing systems
 - Forward looking expertise

- ▶ Avion provides one of the best integration teams with expertise in:
 - **Systems and software for network based architectures**
 - **Agile Software Development, Development Environments**
 - **Hardware and software systems integration**
 - **Avionics systems**

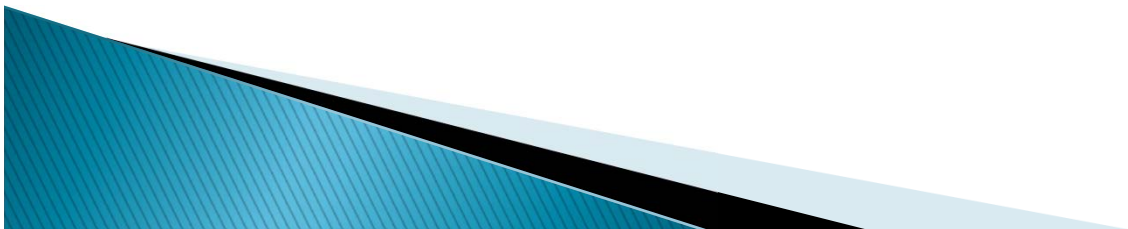

Software Development

AVION

- ▶ Agile processes
 - Iterative development
 - Continuous Integration
 - Unit testing
 - Test Driven Development
 - Code Review
 - Customer Collaboration
- Languages
 - Java, C++, C, Python, Ruby, Shell scripting, LISP, Ada
- Operating Systems
 - Linux/Unix, Open Embedded, Yocto, Windows
- DO-178 projects
 - Level D development
 - Business Aviation Cabin Management Systems
 - Onboard Maintenance Function
 - Network File Server
 - Airbus Airline Network Architecture
 - Level A project management
 - Electronic Circuit Breaker

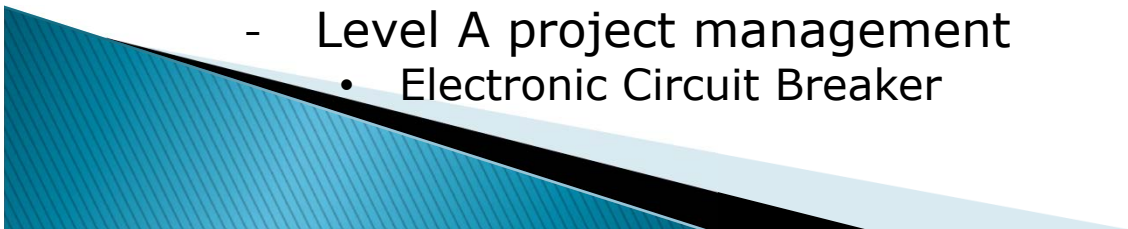

Flight Test and Airworthiness / Certification

AVION

▶ Services

- Flight Test Plans
- Shipline Support
- Test Readiness Review
- Certification Plans
- Boeing Delegated Compliance Organization

▶ Platforms

- Commercial
- Military

▶ Regulatory Authorities

- FAA
- EASA
- Other Foreign Civil Aviation Authorities
- NAVAIR Airworthiness

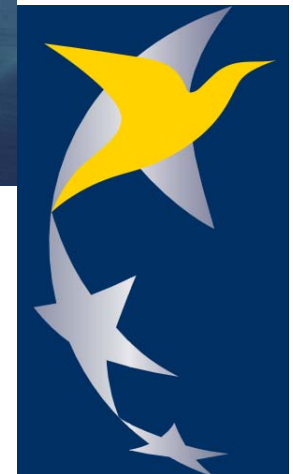

Supplier Management

AVION

- ▶ Supply Chain assessment and selection
- ▶ Evaluate Risk Exposure
 - Capability – Capacity – Financial Stability – Sub-tier Management
- ▶ Manage SOW
- ▶ Risk mitigation and tracking metrics for program and management review

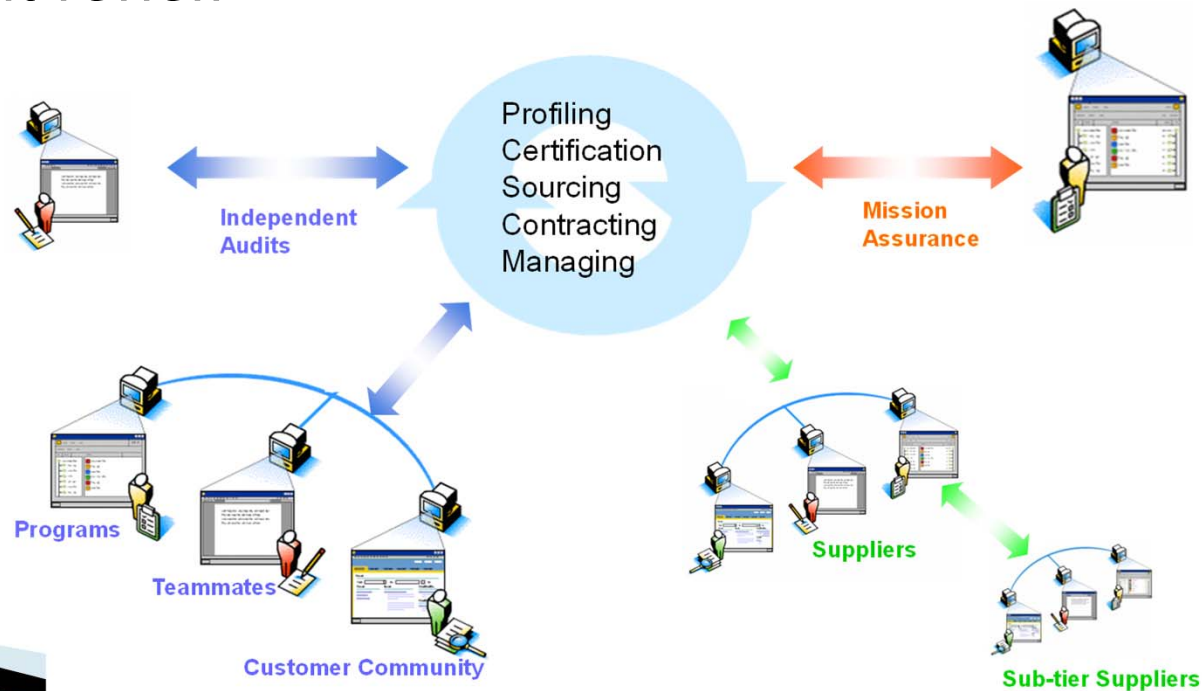

Interim Executives

- ▶ **Interim Aerospace Executives**
 - Avion provides Interim Executive Talent for customers wishing to make changes to their roster while minimizing internal disruption
 - An Interim Executive allows an overt talent search to occur while the organization continues to function.
 - An Interim Executive can also be helpful in implementing strategic changes without attaching a negative legacy to permanent staff.
- ▶ **Part Time Aerospace Executives**
 - When a position requires executive level skills, or leadership, but may not require full time commitment, Avion can provide qualified leadership on a part time basis.
- ▶ **Temporary Remote Support**
 - Avion can provide Executive talent to your remote location allowing you to quickly establish a presence in support of a customer.

Business Development **AVION**

- ▶ Technology and Market Studies
 - Help airlines and OEMs to make informed decisions on selecting the appropriate aircraft systems and technologies
- ▶ Marketing and Sales Support
 - Develop product and marketing strategies as well as provide supplemental staffing
 - Provide business and technical assistance in writing proposals to OEMs and other customers
 - Identify and negotiate partnering and alliance opportunities
- ▶ Mergers and Acquisitions
 - Help identify and evaluate potential M&A opportunities
 - Assess technologies and support for business case
 - Provide guidance and leadership for companies being acquired

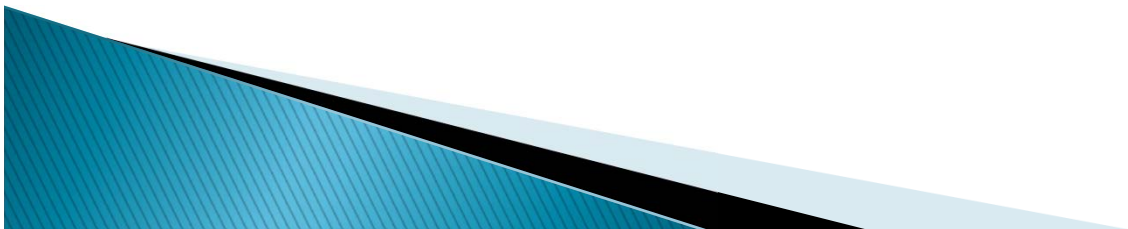

Platforms

▶ Commercial, Military and Business Aviation

- ▶ B727
- ▶ B737-700IGW
- ▶ B737-800
- ▶ B737-900ER
- ▶ B757
- ▶ B767
- ▶ B777
- ▶ B787
- ▶ DC-9
- ▶ C32
- ▶ C40
- ▶ B737 AEW&C
- ▶ Boeing P8A
- ▶ Boeing KC-767A
- ▶ Boeing KC-135
- ▶ Northrop B2-A
- ▶ Rockwell B1-B
- ▶ MD F-18
- ▶ P-8A / P-8I
- ▶ MD80
- ▶ Gulfstream
- ▶ Challenger 604
- ▶ CRJ 100/200
- ▶ Eurocopter EC135



Customers

- ▶ The Boeing Company
- ▶ British Airways
- ▶ General Dynamics
- ▶ THALES
- ▶ GEC Marconi
- ▶ Rockwell Collins
- ▶ PATS Aircraft
- ▶ Astronics
- ▶ Zodiac Lighting Solutions
- ▶ Gogo
- ▶ Tenzing
- ▶ B/E Aerospace
- ▶ Honeywell
- ▶ Northrop Grumman
- ▶ IMS
- ▶ AirCell
- ▶ Greenpoint Technologies
- ▶ iJet
- ▶ Rosen Aviation
- ▶ Southwest Airlines
- ▶ *Several others*

Contact Info

Senior Partners:

- Chris Barnhart
- 12026 115th Ave NE Suite 100
- Kirkland, WA 98034
- 206-650-6580
- cbarnhart@avionpartners.com
- www.avionpartners.com
- Terril Perrine
- 12026 115th Ave NE Suite 100
- Kirkland, WA 98034
- 425-269-9432
- tperrine@avionpartners.com
- www.avionpartners.com

Our mission is to propel our customers to success by acting as a catalyst to their organization

Avion Summary

- ▶ Avion provides short-term support for critical situations as well as long-term support working as part of an organization's staff
- ▶ Our people are highly skilled and the best in their field
- ▶ We generate results and provide solutions to complex program and systems engineering issues
- ▶ We understand aircraft and aircraft systems
- ▶ We integrate seamlessly into an organization and provide leadership and/or technical expertise

Our mission is to propel our customers to success by acting as a catalyst to their organization